

**ISOMETRIC VIEW**

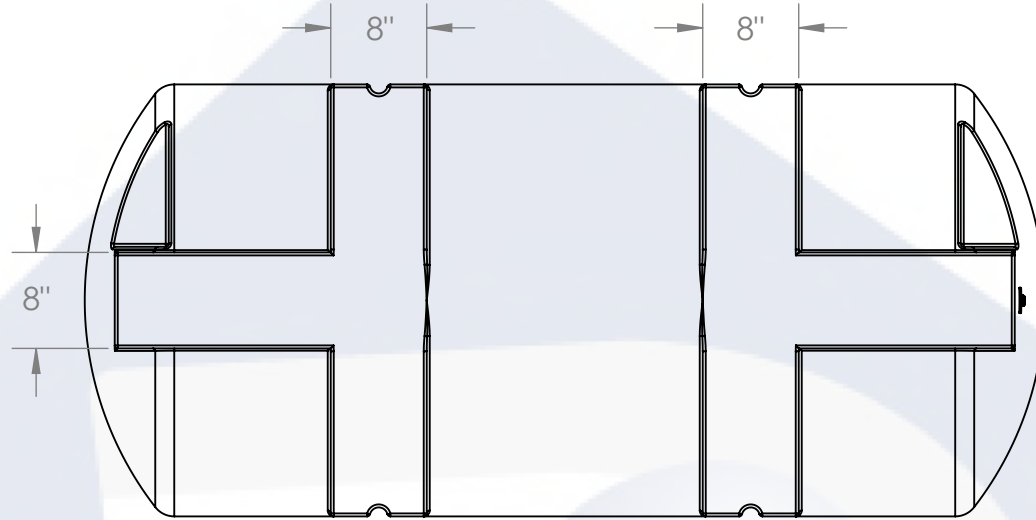

**BOTTOM VIEW**

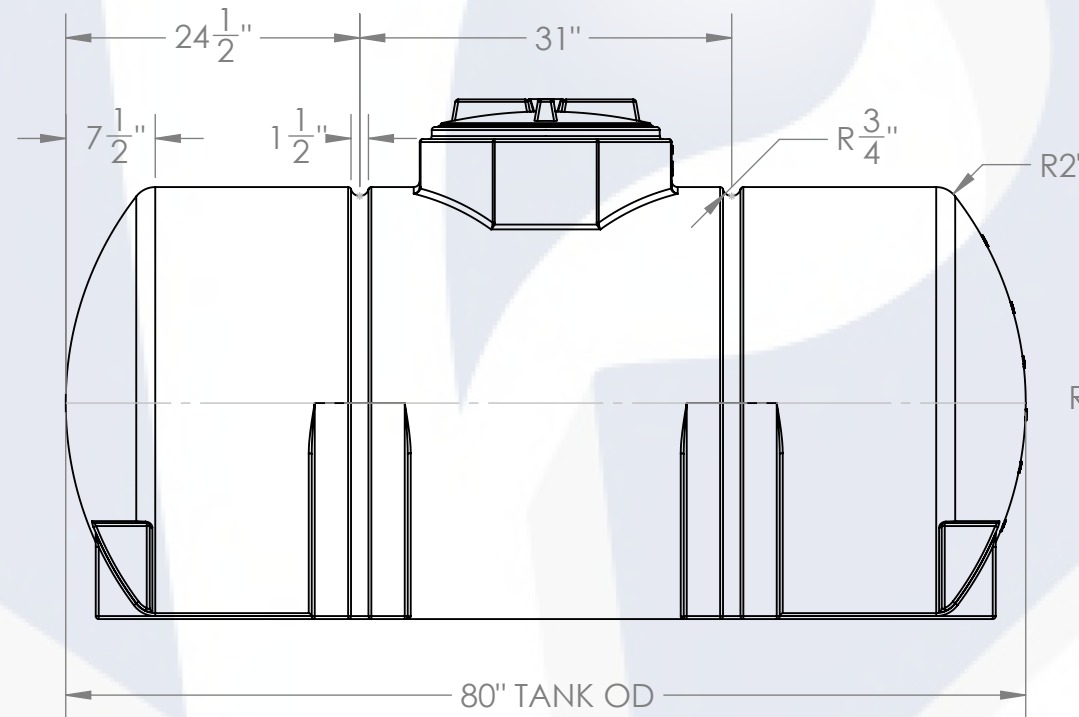

**SIDE VIEW**

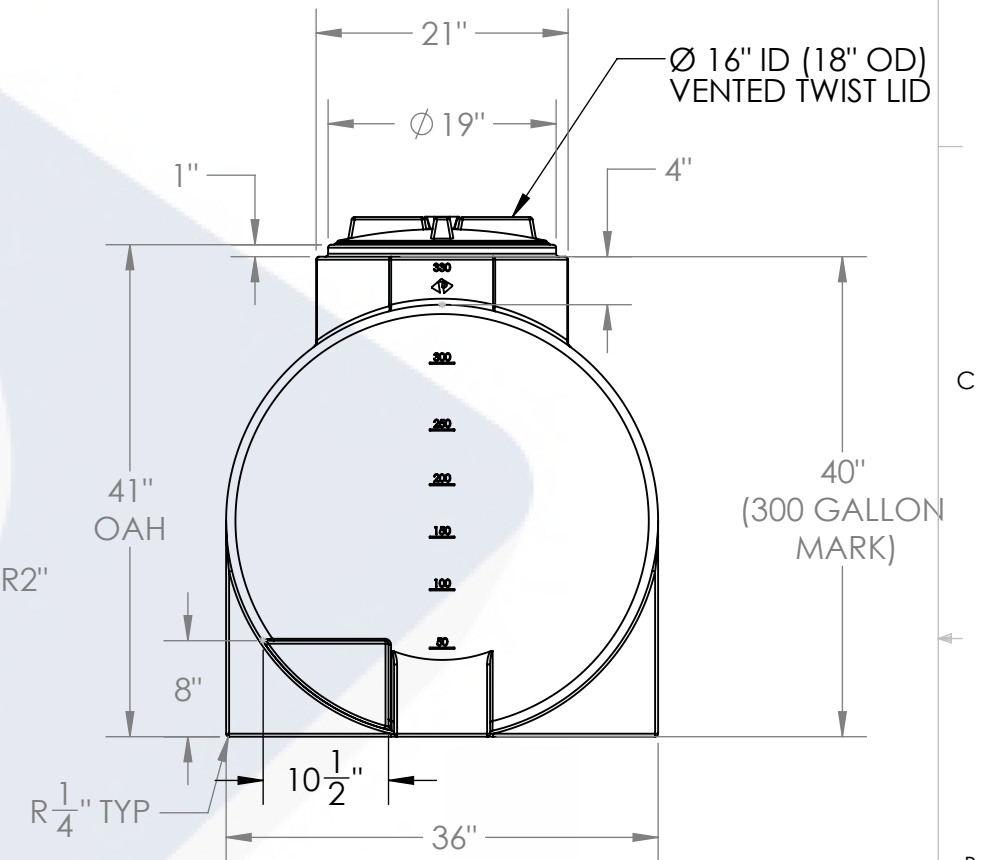

**FRONT VIEW**

**NOTES:**

1. CAPACITY: 330 GAL. NOMINAL
2. APPROXIMATE WEIGHT: 90 LBS
3. TANK MATERIAL: LLDPE W/ UV INHIBITOR
4. SERVICE PRESSURE: ATMOSPHERIC

330G HORIZONTAL PROCHEM	PART NUMBER		
	PROCESS CHEMICAL (NATURAL)	POTABLE WATER (BLACK)	WEIGHT (LBS)
LPE (1.5)	01-35526	N/A	90
LPE (1.9)	01-35531	N/A	100
XLPE (1.9)	01-35537	N/A	N/A
ALTERNATIVE MATERIALS, COLOR, AND ACCESSORIES ARE AVAILABLE. CALL FOR ADDITIONAL INFO			

**PROPRIETARY AND CONFIDENTIAL**  
 THE INFORMATION CONTAINED IN THIS DRAWING IS THE SOLE PROPERTY OF PEABODY ENGINEERING. ANY REPRODUCTION IN PART OR AS A WHOLE WITHOUT THE WRITTEN PERMISSION OF PEABODY ENGINEERING IS PROHIBITED.

UNLESS OTHERWISE SPECIFIED:  
 DIMENSIONS ARE IN INCHES  
 TOLERANCES: ±1/4"  
 ANGULAR: ±.5°  
 ONE PLACE DECIMAL: ±.25  
 TWO PLACE DECIMAL: ±.125  
 THREE PLACE DECIMAL: ±.063  
 TANK MATERIAL: LPE 1.5  
 INNER TANK S/N:  
 OUTER TANK S/N:  
 CUSTOMER PO#  
 DO NOT SCALE DRAWING

NAME	DATE	PROJECT: 330G HORIZONTAL PROCHEM	
DRAWN: JO	04/01/24	CUSTOMER: PEABODY STANDARD	
CHECKED:		SITE/LOCATION:	
ENG APPR.:		DRAWING#:	
MFG APPR.:		SIZE: B	DESC. 330G HORIZONTAL PROCHEM
Q.A.:		SCALE: 1:16	REV. A
ALTERNATIVE VERSIONS		SHEET 1 OF 1	
MATERIALS: XLPE, PPL, PVDF COLORS: NATURAL, BLUE OR BLACK AVAILABLE WITH FRP WRAP		CALL FOR PART NUMBERS	