

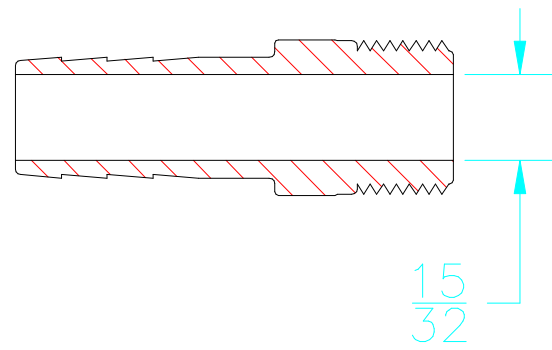

1/2" NPT PER  
ANSI B2.1-1968

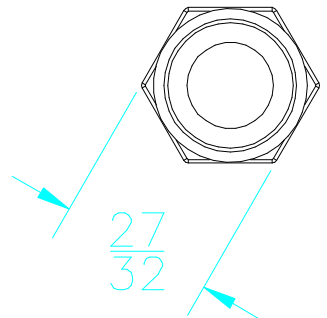
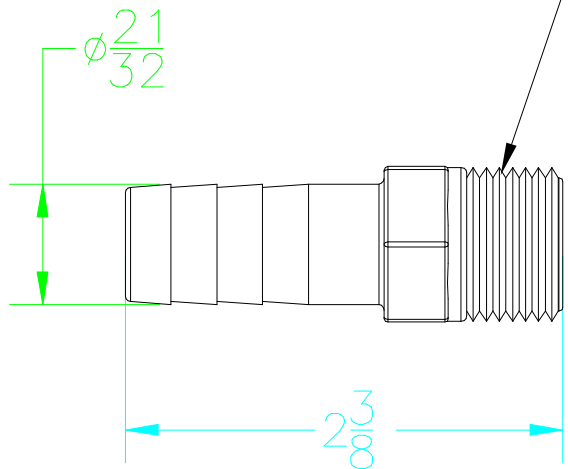

THIS DRAWING AND ALL INFORMATION  
CONTAINED THEREON ARE THE EXCLUSIVE  
PROPERTY OF BANJO CORPORATION.  
UNLESS SPECIFICALLY NOTED, THIS  
DRAWING AND ITEMS SHOWN ON THIS  
DRAWING ARE SUBJECT TO CHANGE  
AT ANY TIME.

 LIQUID HANDLING PRODUCTS
BANJO CORPORATION 150 BANJO DR. * CRAWFORDSVILLE, IN 47933
PART NO. HB050058SS
TITLE 1/2" MNPT X 5/8" HOSE BARB 316 SS