

Catalog Options:
Cover #9194

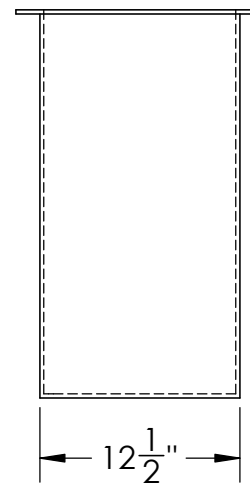

Polypropylene High
Temperature Rectangular
Tank #9168

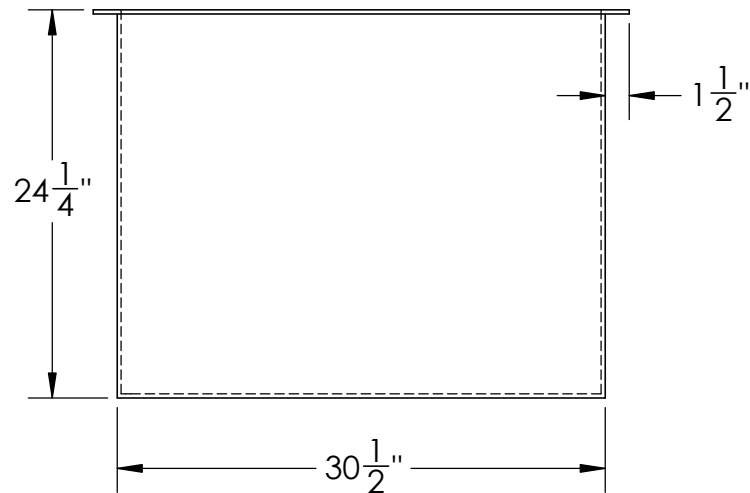
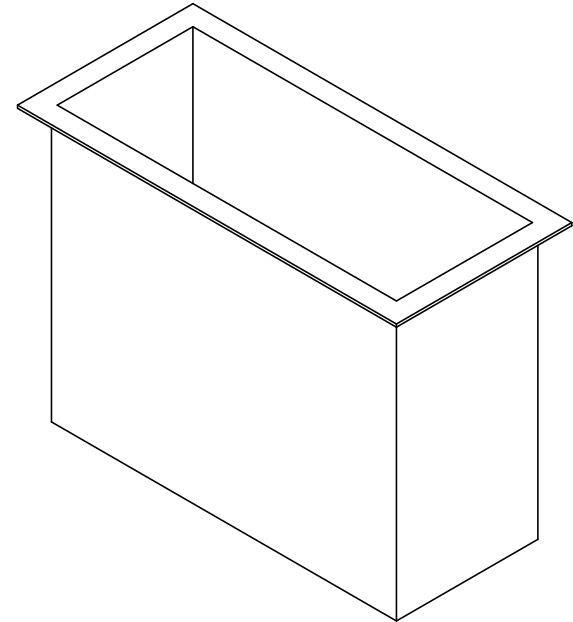

1390 Neubrecht Road
Lima, Ohio 45801

STOCK NO.

9168

REV

A

DO NOT SCALE DRAWING

WEIGHT: 50.8 lbs.

DIMENSIONS ARE IN INCHES
TOLERANCE: ± 1/4"

MATERIAL
POLYPROPYLENE

CAPACITY
37 US gal.

GRADUATIONS
N/A

NOMINAL WALL THICKNESS
1/4"

	NAME	DATE
DRAWN	CDH	07/05/16
APPROVED	BAT	07/14/16

COMMENTS:

Welded
Construction

PROPRIETARY AND CONFIDENTIAL

THE INFORMATION CONTAINED IN THIS
DRAWING IS THE SOLE PROPERTY OF
TAMCO. ANY REPRODUCTION IN PART
OR AS A WHOLE WITHOUT THE WRITTEN
PERMISSION OF TAMCO IS PROHIBITED.

MAX. OPERATING TEMP. 200°F
SEE CHEMICAL RESISTANCE
CHART FOR COMPATABILITY